

ITEM

1820NN54B0

PROLUNGA UNI FEMM 1"1/4X32X165

Product Type

Logistic Info

Pcs per Carton: 50
Qty per Pallet: 50
Unit weight: 0,03880
Flow rate Lt/m.:

ORIGINE: MADE IN ITALY

Cod.EAN13: 8030575013336

Tarif Code :39229000

Tecnichal Details

Model: EXTENSION PIPES
Product: Female connection extension
Spec 1: Female connection, conical washer
Spec 2: 1"1/4 x 32 x 165 mm
Material 1: PP
Material 2:
Color 1: WHITE
Color 2:

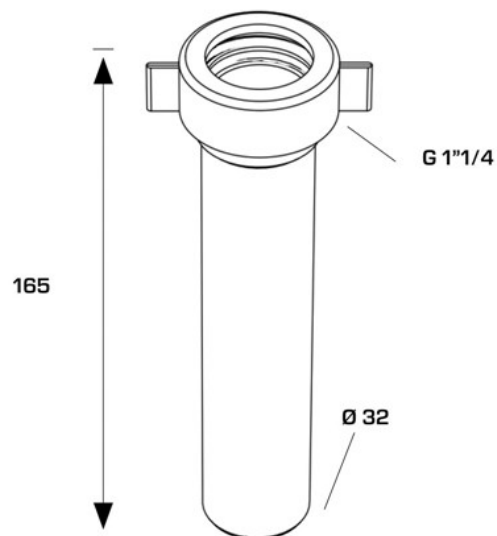

Approvals